



BANLAW

"innovative refuelling specialists"

www.banlaw.com

LubeCentral™



Ⓐ Flush Face

Ⓥ Classic



LubeCentral™ Hi-Flow Oil & Coolant Fittings

Are your Oil & Coolant service times slow and forcing dirt into your valuable machinery fluids? Banlaw's LubeCentral™ **Flush Face** and **Classic Range** of Hi-Flow Oil & Coolant fittings may solve these common problems.

• FillSafe • FuelTrack • LubeCentral • ReFuelling •



BANLAW

"innovative refuelling specialists"

LubeCentral™

On Vehicle Locations for LubeCentral™ Service Box

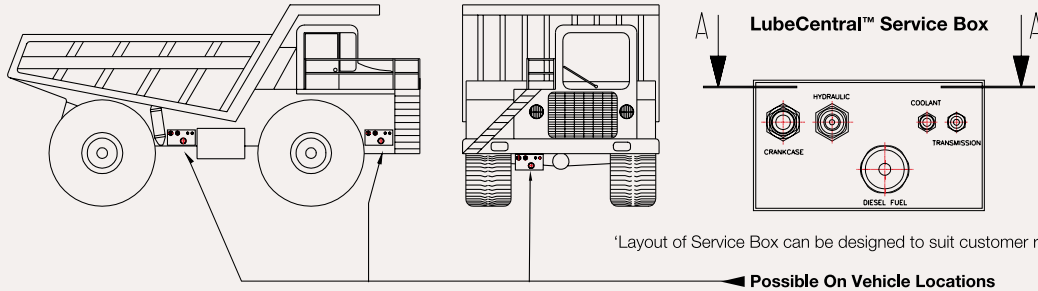

Flush Face Range



Higher flow capability to provide more efficient service intervals

- The fittings are physically larger in size – up to 1-1/4".
- Available in NPT thread sizes to suit both current industry specifications and larger configurations to maximise the flowrate capability.
- Sound engineering design of the internal fluid flow path.

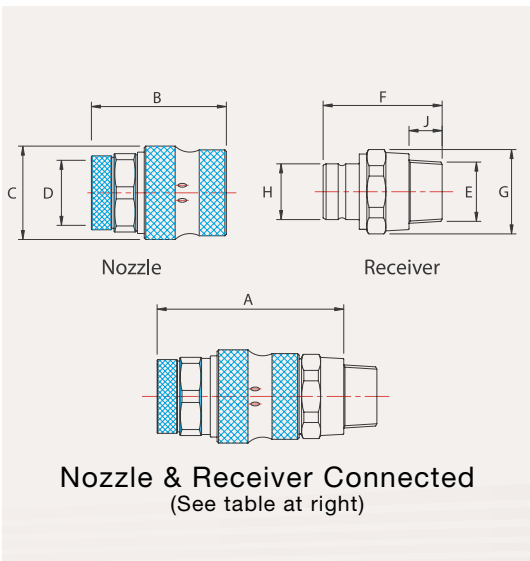

Fitting Type	Dimensions								
	A	B	ØC	D	E	F	G	ØH	J
BPLR0 BPLN0	84.9	59.5	34.4	1/4" BSPF	1/4" BSPM	52.2	25	14.5	13
BPLR1 BPLN1	91.5	64	46	*	*	63	41	24	20
BPLR2 BPLN2	93.5	65	48	*	*	66	46	25	21
BPLR3 BPLN3	97.0	68	50	*	*	67.5	46	28	21
BPLR4 BPLN4	110.5	76.5	55	*	*	75.5	50	31.5	21
BPLR5 BPLN5	115.5	80	58	*	*	79	53	33	22
BPLR6 BPLN6	124.0	89.5	62	*	*	79	56	37	22

NPT Thread Configurations - Receivers (Male) - Nozzles (Female)

- Size 0 Couplings available with 1/4" on Receiver and Nozzle. (BSP)
- Size 1 Couplings available with 1/2" & 3/4" on Receiver and 3/4" & 1" on Nozzle. (NPT)
- Size 2,3,4 & 5 Couplings available with 3/4" & 1" on Receiver and Nozzle. (NPT)
- Size 6 Couplings available with 1" & 1-1/4" on Receiver and Nozzle. (NPT)

Delivery & Evacuation Hoses

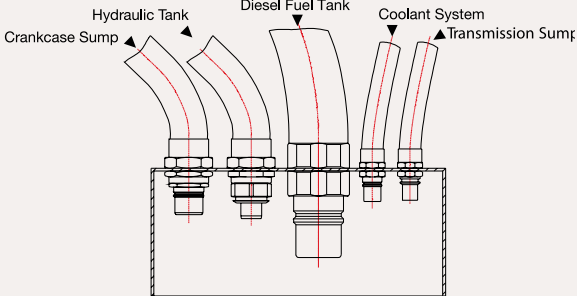

Section A-A



Typical Service Box Layout



Service Box Fitted to Heavy Haul Mine Vehicle

Flush-face to minimise contamination

Both the nozzle and mating receiver are a “flush face” design, without the traditional recesses to trap harmful contamination between mating fittings. This minimises the extent of contamination entering the fluid stream during servicing and reduces wear on mating seals and other components within the fittings.

Push-to-Connect

Without the need to manually retract the nozzle actuating collar during connection, the operator needn't struggle to ensure proper engagement of the fittings.

Colour coded

Each set is uniquely colour coded to assist the operator in identifying mating fittings.

Banlaw durability

Unlike some other fittings on the market, this new range is “designed for the job”. It retains the trademark Banlaw features including the secure ball-lock latching mechanism and rugged electroplated steel construction of vital parts. This maximises the working life of each fitting and provides a safer work environment for the operator.

NPT Threads Supplied as Standard

		Size 1		Size 2		Size 3		Size 4		Size 5		Size 6	
		N	C	N	C	N	C	N	C	N	C	N	C
SWP	MPa	6.5	6	10	8.75	6.75	8.75	6.5	7	7	5	5	4.5
	psi	943	870	1450	1269	979	1269	943	1015	1015	725	725	653
BP	MPa	26	24	40	35	27	35	26	28	28	20	20	18
	psi	3771	3481	5801	5076	3916	5076	3771	4061	4061	2901	2901	2611

Legend

SWP - Safe Working Pressure (Maximum Recommended Working Pressure)

BP - Burst Pressure (Minimum Pressure at which Failure Will Occur)

N - Nozzle **C** - Nozzle and Receiver Coupled

Fluids: The **Size 1** of the couplings are manufactured from Brass and are suitable for compatible coolants and water. The **Size 2,3,4,5 & 6** couplings are manufactured from Zinc plated steel and anodised aluminium and are suitable for use with common lubricants and diesel fuel. **Size 6 is also suitable with ULP.**

Seals: All couplings are fitted with Viton and HNBR seal compounds. If in doubt, please verify seal compatibility with fluid prior to use.





BANLAW

"innovative refuelling specialists"

Classic Range

Crankcase

- Commonly used to fill and evacuate crankcase oils
- Safe Working Pressures;
 - AUS27W : 10 MPa (1450 psi)
 - AUS29W & AUS29L : 3 MPa (435 psi)
 - Coupled Nozzle & Receiver : 4.75 MPa (690 psi)
- Max. recommended flow rate : 100 LPM (26.4 GPM) - ISO 46 oil



AUS27W & AUS29W Assemblies shown with optional Caps/Plugs

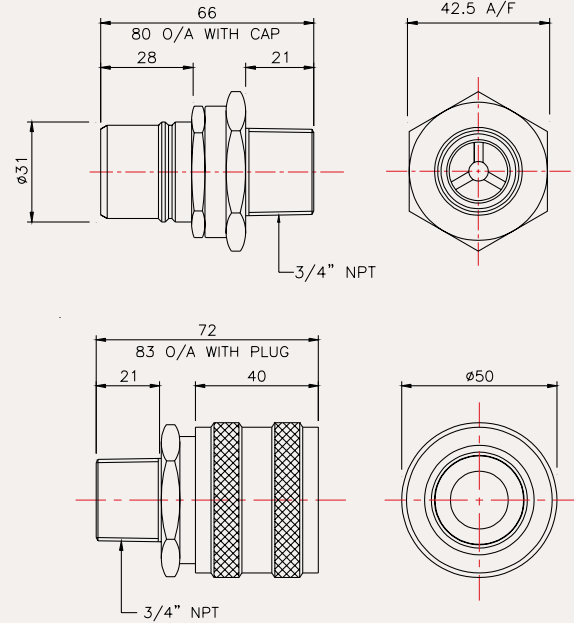

Top: AUS27W Receiver shown
Bottom: AUS29W Nozzle shown

Transmission

- Commonly used to fill and evacuate transmission oils
- Safe Working Pressures;
 - AUS32W : 4.25 MPa (615 psi)
 - AUS33W : 10 MPa (1450 psi)
 - Coupled Nozzle & Receiver : 11.5 MPa (1670 psi)
- Max. recommended flow rate : 30 LPM (7.9 GPM) - ISO 46 oil

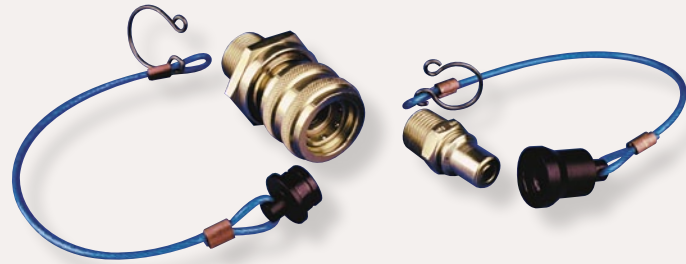

AUS32W & AUS33W shown with optional Caps/Plugs

Hydraulic

- Commonly used to fill and evacuate hydraulic oils
- Safe Working Pressures;
 - AUS34A : 10 MPa (1450 psi)
 - AUS41A : 10 MPa (1450 psi)
 - Coupled Nozzle & Receiver : 4.0 MPa (580 psi)
- Max. recommended flow rate : 100 LPM (26.4 GPM) - ISO 46 oil



AUS34A & AUS41A shown with optional Caps/Plugs

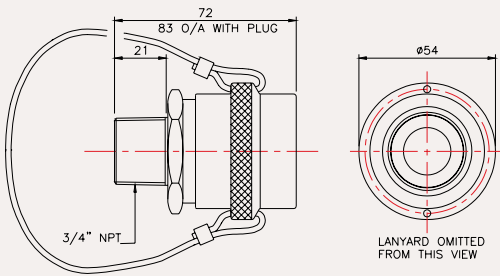
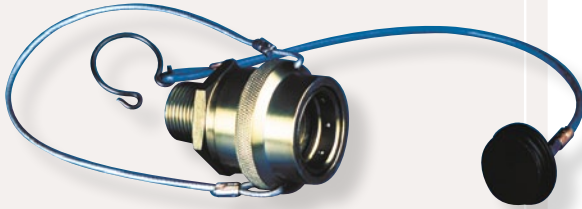

Top: AUS29L shown with optional plug
 Bottom: AUS29L alternative Nozzle incorporating Lanyard on Acuator

Part Numbers

Type	Basic Fitting	Tailpiece			Additional Part	
		1/2" NPT	3/4" NPT	1-1/16" JIC	Plug	Cap
Crankcase	AUS27W	27W-B	STD	27WB/H	-	AUS27W-C
	AUS29W	29W-B	STD	29WB/H	AUS29W-P	-
	AUS29L	29L-B	STD	29LB/H	AUS29L-P	-
Transmission	AUS32W	32W-B	STD	32WB/H	AUS32W-P	-
	AUS33W	STD	-	33WB/H	-	AUS33W-C
Hydraulic	AUS34A	*	STD	34AB/H	AUS34A-P	-
	AUS41A	*	STD	41AB/H	-	AUS41A-C
Coolant	AUS36A	36A-B	STD	36AB/H	AUS36A-P	-
	AUS37W	STD	-	37WB/H	-	AUS37W-C
Push to connect	AUS38W	*	STD	38WB/H	-	AUS38W-C
	AUS39W	*	STD	39WB/H	-	-
Alternative	AUS80A	-	-	-	-	AUS80A-C
	AUS81A	-	-	-	AUS81A-P	-

*Not Standard Product - But can be supplied on request.
 Standard: supplied as standard - option not applicable

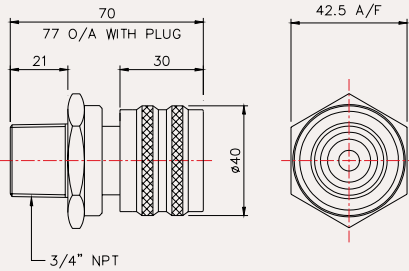

AUS32W Nozzle shown

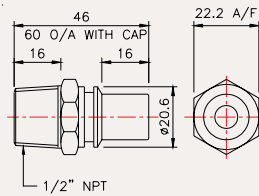

AUS33W Receiver shown

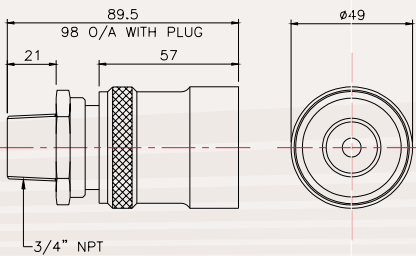

AUS34A Nozzle shown

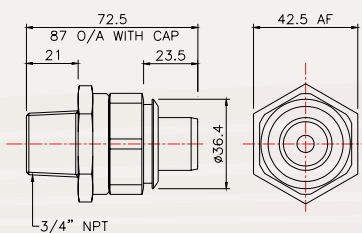

AUS41A Receiver shown





Coolant

- Commonly used to fill and evacuate coolant fluids
- Safe Working Pressures;
 - AUS36A : 10 MPa (1450 psi)
 - AUS37W : 10 MPa (1450 psi)
 - Coupled Nozzle & Receiver : 7.5 MPa (1090 psi)
- Max. recommended flow rate : 40 LPM (10.6 GPM) - Water (estimated)

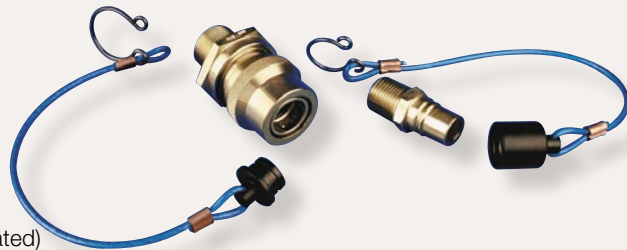

AUS36A & AUS37W shown with optional Caps/Plugs

Push To Connect

- Commonly used to fill and evacuate oils
- Safe Working Pressures;
 - AUS38W : 10 MPa (1450 psi)
 - AUS39W : 1.5 MPa (217 psi)
 - Coupled Nozzle & Receiver : 10 MPa (1450 psi)
- Max. recommended flow rate : 100 LPM (26.4 GPM) - ISO 46 oil



AUS39W & AUS38W Assemblies AUS38W shown with optional Caps

Alternative fittings

- Alternative higher flow fittings used to fill and evacuate oils
- Safe Working Pressures;
 - AUS80A : 6 MPa (870 psi) - R18 equivalent
 - AUS81A : 2.5 MPa (365 psi) - R17 equivalent
 - Coupled Nozzle & Receiver : 2.5 MPa (365 psi)
- Max. recommended flow rate : 180 LPM (47.6 GPM) - ISO 46 oil



AUS81A & AUS80A shown with optional Caps/Plugs

Grease

- Banlaw AUSGR & AUSGN fittings are specifically designed for the bulk transfer of grease
- Provides ease of connection
- Able to connect/disconnect under pressure, utilising a standard off the shelf valve on the delivery line
- Robust, zinc plated
- Easy to use

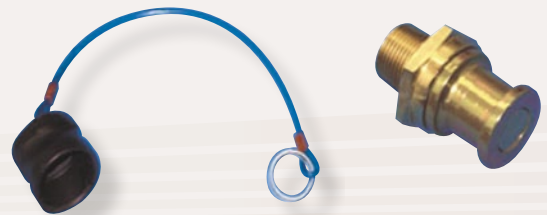

Receiver Cap AUSGC shown

Receiver AUSGR shown

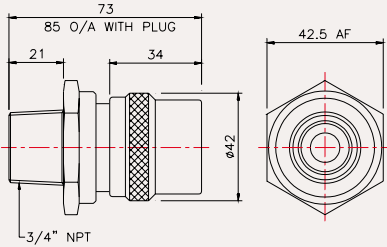

AUS36A Nozzle shown

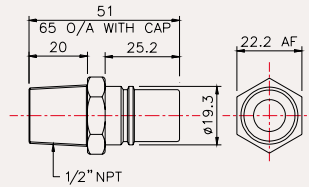

AUS37W Receiver shown

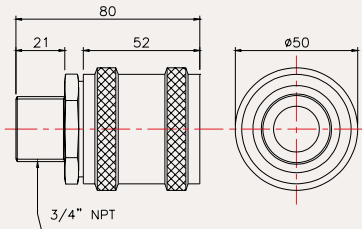

AUS38W Receiver shown

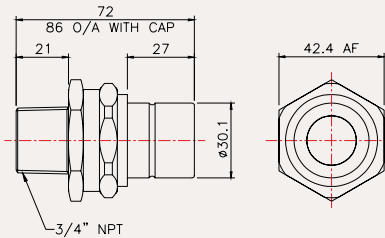

AUS39W Nozzle shown

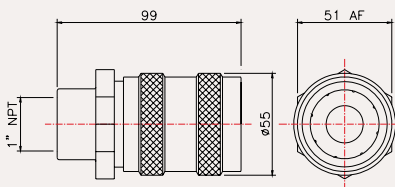

AUS81A Nozzle shown

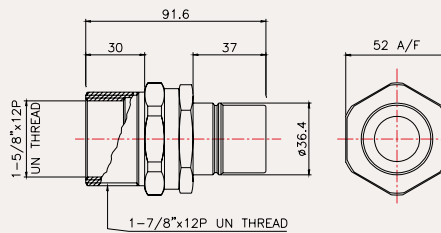

AUS80A Receiver shown

Improved Safety

- All fittings incorporate Dry-Break Technology to eliminate spillage
- Higher safe working pressure
- Each set is unique and cannot be accidentally connected. Ensures "right fluid into right reservoir"
- All fittings incorporate Banlaw's trademark ball lock latching system achieving a reliable higher strength connection between nozzle & receiver

Environmental Performance

- No spillage means Environment Protection Authority compliance
- The efficient evacuation systems allows for complete used oil/coolant recovery for total recycling of waste
- Complete recovery means more accurate waste records



Nozzle AUSGN shown



Nozzle Plug AUSGNP shown

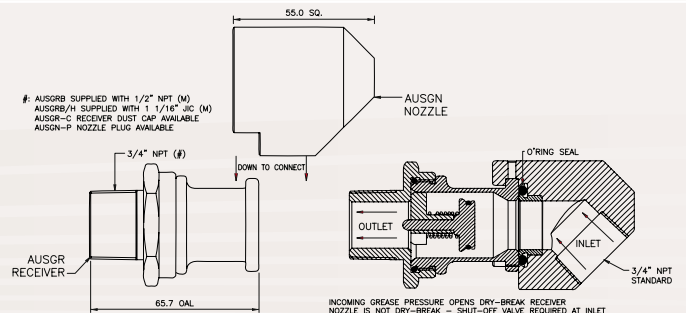

AUSGR and AUSGN shown

One Way Valve

- Non spring-loaded ball design
- 1/2" NPT (F) threaded connection each side
- Zinc-plated mild steel construction with diesel and oil resistant polypropylene ball and Viton seals
- Commonly used on fuel return line from diesel fuel injector pump, to prevent back flow into pump during refuelling

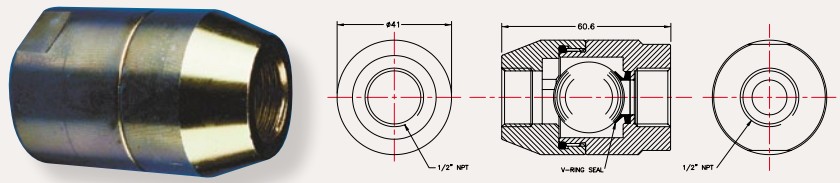

One Way Valve shown

AUS3W

Oil Sample Valve

- Spring loaded poppet valve design
- 3/4" NPT (F) threaded connection each side
- Choice of two ACME threads to secure most common sample bottles to sample outlet
- Aluminium construction, with Viton seals
- Commonly installed into oil fill and evacuation line, typically located in central service box

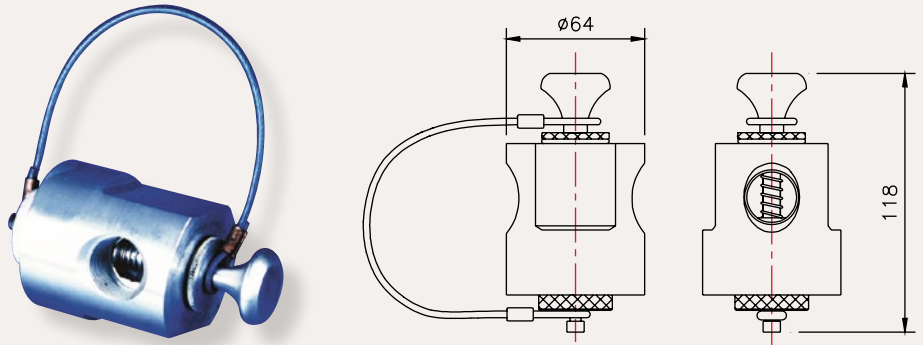

Oil Sample Valve

AUSV3

Technical Specification

1. A safety factor of approx. 4 has been applied to the burst pressure in order to obtain the Safe Working Pressures (S.W.P.) quoted in this brochure.
2. Unless noted otherwise, all fittings are manufactured from zinc plated steel components, fitted with Viton seals. Similarly, all plugs and caps are manufactured from Acetal (plastic).



Call for a full consultation Pty. Ltd.

19 Metro Court Gateshead NSW 2290 Australia

t: +61 (0)2 4922 6300 f: +61 (0)2 4920 6171

w: www.banlaw.com e: sales@banlaw.com.au

ABN 88 062 044 071

Call your authorised agent

Please Note: Use only Banlaw factory replacement parts. Failure to do so may cause equipment failure or malfunction, vehicle damage and invalidate factory warranty.